

**SHEAREX**

# LAND CLEARING ATTACHMENTS





## MULCHERS

- 6 **Front Mount Bite Limiter Mulcher**
- 8 **Solid Drum Mulcher**
- 10 **Excavator Bite Limiter Mulcher**
- 12 **Excavator Mini Bite Limiter Mulcher**
- 14 **Startup Service**
- 14 **Customer Kit**
- 15 **Blade Types**

## FORESTRY ATTACHMENTS

- 18 **Harvester Shear**
- 19 **Stump Shear**
- 20 **Tree Shear**
- 21 **Mini Tree Shear**
- 21 **Wood Cone Splitter**
- 22 **Stump Grinder**
- 23 **Brush Grapple**

Shearex is part of GRYB International, a group of companies offering attachment solutions in the material handling, forestry & land clearing, steel production & distribution, construction, and ag & light industrial industries.



### GRYB FORESTRY & LAND CLEARING

Shearex's products are part of the GRYB Forestry & Land Clearing division. Our solutions optimize your operations, setting the industry standards for performance and reliability. Engineered with precision and durability, they ensure efficient land management with optimal results.



**DANGER** STAND CLEAR 500'

**SHEAREX**  
HYDRA-EX



A photograph of a mulcher machine in a wooded area. The machine is white and black, with a large pile of mulch in the foreground. The background is filled with trees and green foliage. The word "MULCHERS" is written in large, bold, white letters on an orange background across the middle of the image.

# MULCHERS



# FRONT MOUNT BITE LIMITER MULCHER

## HM SERIES

Shearex's HM bite limiter mulcher is the ultimate tool for fast and efficient roadside maintenance, invasive species removal, land clearing, and underbrush maintenance.

The front-mount hydraulic mulcher offers the speed and power to complete any land-clearing job.

## HYDRAULIC PUSH BAR

The hydraulic push bar is a convenient piece of equipment that allows the aligning and control of materials during mulching operation.

Reliable and robust, it has been built for heavy duty operations for all the SV models of HM series.



## G2.0 BALANCING STANDARD ZERO VIBRATION ROTOR

We are the only mulcher manufacturer to adhere to the highest vibration standards in the market, the G2.0 Balancing quality. Optimal balance is crucial to minimize vibrations, premature bearing wear, and structural fatigue.



## BLADE ANGLE OPTIMISED FOR A PERFECT CUT AND LONGER UTILISATION

Our blade mount design provides greater durability and cutting power. The rotor maintains its power throughout the tooth life.



## PROTECTION SYSTEM CONVEX DX™

Our patented Convex DX system uses a double-ring to force the material towards the center of the tooth, effectively reducing the amount of material being cut per pass and alleviating strain on the blade holder.

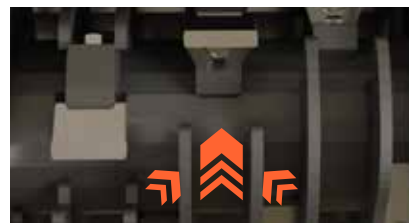



**High visibility.**

**Bolt-on liner and skid shoes made of Hardox® for ultimate wear resistance. Easy maintenance or replacement.**

**Closer center of gravity for better handling.**

**Robust rotor design.**

**High torque variable and adjustable motor.**

**Up to 100 inches cutting width.**

**Innovative oil cooling system: Cools the oil when running idle, resulting in a temperature reduction of 30 to 50°C.**

		HM-60SR	HM-70SR	HM-70DR	HM-70SV	HM-88LV	HM-90SV	HM-100SV2
<b>Recommended Minimum Carrier Power</b>	HP (KW)	68 (50)	74 (55)	74 (55)	125 (95)	140 (104)	170 (127)	250 (190)
<b>Cutting Width</b>	IN (CM)	59 (149)	75 (190)	75 (190)	75 (190)	87 (220)	91 (230)	100 (254)
<b>Cutting Dist. from Ground Level</b>	IN (CM)	0.4 (1)	0.4 (1)	0.4 (1)	0.4 (1)	0.4 (1)	0.4 (1)	0.4 (1)
<b>Number of Blades on Rotor</b>		21	27	27	24	28	33	36
<b>Optimal Target Material Diameter</b>	IN (CM)	6 (15)	8 (20)	8 (20)	10 (25)		15 (40)	24 (60)
<b>Exterior Length</b>	IN (CM)	49.25 (125)	49.25 (125)	48 (124)	48.75 (124)	50 (126)	47 (118)	47 (118)
<b>Exterior Height</b>	IN (CM)	51 (129)	51 (129)	57 (146)	59 (150)	59 (150)	53 (134)	59 (150)
<b>Exterior Width</b>	IN (CM)	72 (183)	89 (226)	89 (226)	90 (228.25)	102 (259)	106 (269)	118 (300)
<b>Rotor Diameter</b>	IN (CM)	17.625 (45)	17.625 (45)	17.625 (45)	20 (50)	20 (50)	20 (50)	20 (50)
<b>Approximate Typical Weight</b>	LBS (KG)	2,300 (1,043)	3,000 (1,361)	3,285 (1,490)	3,640 (1,655)	3,880 (1,760)	4,272 (1,938)	5,094 (2,311)

## HYDRAULICS

<b>Variable Displacement Axial Piston Motor</b>	CC	80	110	110	160	160	160	2x160
<b>Min. Required Continous Flow</b>	GAL/MIN (L/MIN)	23 (87)	33 (125)	33 (125)	47 (178)	47 (178)	47 (178)	95 (360) for 160cc 70 (265) for 110cc
<b>Max Required Continuous Flow</b>	GAL/MIN (L/MIN)	42 (159)	54 (204)	54 (204)	76 (288)	76 (288)	76 (288)	150 (568)
<b>Max. Operating Pressure</b>	PSI (BAR)	6,000 (410)	6,000 (410)	6,000 (410)	6,000 (410)	6,000 (410)	6,000 (410)	6,000 (410)
<b>Rotating Speed</b>	RPM	2,600	2,600	2,600	2,500	2,500	2,300	2,300

## FEATURES

<b>Hydraulic Push Bar</b>	N/A	N/A	N/A	Optional	N/A	Optional	Optional
<b>Front Deflector</b>	N/A	N/A	Included	N/A	N/A	N/A	N/A
<b>Hydraulic Motor Option</b>	N/A	N/A	N/A	N/A	N/A	N/A	2 x 110cc

This information is subject to change without notice.



# FRONT MOUNT SOLID DRUM MULCHER

## HD SERIES

Introducing Shearex's HD solid drum mulcher, the new benchmark for mulching in rough terrain. Ideal for operation in loam, clay and rocky soils, you can easily push through dense vegetation.

With double carbide teeth, counter blades and Hardox® 500 bolt-on liner and skid shoes, the HD Solid Drum provides increased efficiency and durability. Take your land clearing capabilities to the next level with the unmatched performance of Shearex's solid drum mulcher.

## G2.0 BALANCING STANDARD ZERO VIBRATION ROTOR

We are the only mulcher manufacturer to adhere to the highest vibration standards in the market, the G2.0 Balancing quality. Optimal balance is crucial to minimize vibrations, premature bearing wear, and structural fatigue.

The HD series mulcher is comprised of double carbide hammers and high resistance carbide teeth on both ends for optimal durability and performance. Cutting edge counter blades provide maximum mulching efficiency and quality. Bolt-on inner blades for easy maintenance and optimized uptime.



STANDARD & HIGH RESISTANCE





**Robust rotor design.**

**Hardox® 500 liner and skid shoes for maximum wear resistance.**

**Bolt-on and welded liner for simplified maintenance.**

**High visibility.**

**Fastest rotor recovery.**

**Unique hose guard to avoid getting tangled in branches.**

**High pressure hoses included.**

**High torque variable and adjustable motor.**

**Innovative oil cooling system: Cools the oil when running idle, resulting in a temperature reduction of 30 to 50°C.**

**Low rotor maintenance.**

		<b>HD-60SX</b>	<b>HD-70SY</b>	<b>HD-100DY2</b>
<b>Recommended Carrier Power</b>	HP (KW)	74 (55)	125 (95)	250 (190)
<b>Cutting Width</b>	IN (CM)	58.625 (149)	74.75 (190)	100 (254)
<b>Cutting Dist. from Ground Level</b>	IN (CM)	0.4 (1)	0.4 (1)	0.4 (1)
<b>Number of Hammers on Rotor</b>		34	46	60
<b>Optimal Target Material Diameter</b>	IN (CM)	8 (20)	10 (25)	24 (61)
<b>Exterior Length</b>	IN (CM)	43.42 (110)	49.5 (126)	49.6 (126)
<b>Exterior Height</b>	IN (CM)	56.1 (142)	59.3 (151)	59.4 (151)
<b>Exterior Width</b>	IN (CM)	72.56 (184)	94 (239)	119 (302)
<b>Rotor Diameter</b>	IN (CM)	16.25 (41.3)	18 (45.7)	18 (45.7)
<b>Approximate Typical Weight</b>	LBS (KG)	2,815 (1,277)	3,100 (1,406)	5,500 (2,495)

## HYDRAULICS

<b>Variable Displacement Axial Piston Motor</b>	CC	110	160	2 x 160
<b>Min. Required Continuous Flow</b>	GAL/MIN (L/MIN)	28 (106)	47 (178)	64 (242)
<b>Max. Allowed Continuous Flow</b>	GAL/MIN (L/MIN)	46 (174)	76 (288)	150 (568)
<b>Max. Operating Pressure</b>	PSI (BAR)	6,000 (410)	6,000 (410)	6,000 (410)
<b>Rotating Speed</b>	RPM	2,300	2,200	2,100

## FEATURES

<b>Hydraulic Push Bar</b>	N/A	N/A	Optional
<b>Front Deflector</b>	Optional	Optional	Optional
<b>210 CC Motor</b>	Optional	Optional	Optional
<b>Hydraulic Motor Option</b>	N/A	N/A	2 x 110 CC
<b>Bite Limiter Rotor</b>	Optional	N/A	N/A

This information is subject to change without notice.



# EXCAVATOR BITE LIMITER MULCHER

## VM SERIES

### COUPLING

Shearex provides the standard attachment bracket to couple the mulcher to the carrier. Shearex is also able to make a coupler adapted to any brand of carrier you might have.



### TILTING SYSTEM

Essential tool for facilitating work at height for the operator of an excavator by more easily visualizing the trajectory of the mulcher's rotor.



### OPTIONAL GRAPPLE SYSTEM

Move and sort through smaller material or pile them up for greater mulching control.



### G2.0 BALANCING STANDARD ZERO VIBRATION ROTOR

We are the only mulcher manufacturer to adhere to the highest vibration standards in the market, the G2.0 Balancing quality. Optimal balance is crucial to minimize vibrations, premature bearing wear, and structural fatigue.



### BLADE ANGLE OPTIMISED FOR A PERFECT CUT AND LONGER UTILISATION

Our blade mount design provides greater durability and cutting power. The rotor maintains its power throughout the tooth life.



### PROTECTION SYSTEM CONVEX DX™

Our patented Convex DX system uses a double-ring to force the material towards the center of the tooth, effectively reducing the amount of material being cut per pass and alleviating strain on the blade holder.

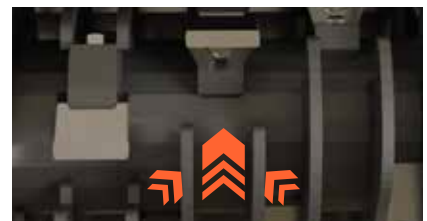



**High visibility.**

**Poly-Chain® Carbon transmission belt.**

**Bolt-on liner and skid shoes made of Hardox® 500 for ultimate wear resistance. Easy maintenance and replacement.**

**Robust rotor design.**

**High torque variable and adjustable motor.**

**Innovative oil cooling system: Cools the oil when running idle, resulting in a temperature reduction of 30 to 50°C.**

		<b>VM-25SK</b>	<b>VM-35SK</b>	<b>VM-40SL</b>	<b>VM-50SR</b>	<b>VM-60SR</b>	<b>VM-65SV</b>
<b>Excavator Size</b>	TONS (LBS)	5 to 8 (11,000 to 18,000)	6 to 12 (14,000 to 26,000)	12 to 15 (26,000 to 33,000)	15 to 20 (33,000 to 44,000)	20 to 25 (44,000 to 55,000)	25 to 40 (55,000 to 88,000)
<b>Recommended Min. Carrier Power</b>	HP (KW)	37 (50)	40 (54)	48 (65)	59 (80)	96 (130)	127 (170)
<b>Cutting Width</b>	IN (CM)	28 (70)	37 (95)	42 (107)	48 (123)	59 (149)	65 (165)
<b>Cutting Dist. from Ground Level</b>	IN (CM)	0.25 (0.64)	0.25 (0.64)	0.25 (0.64)	0.25 (0.64)	0.25 (0.64)	0.87 (2.2)
<b>Number of Blades on Rotor</b>		9	13	14	17	21	21
<b>Opt. Target Material Dia.</b>	IN (CM)	<4 (<10)	4 (10)	6 (15)	10 (25)	15 (40)	20 (50)
<b>Exterior Length</b>	IN (CM)	41 (104)	50 (127)	57 (145)	66 (168)	77 (194)	89 (225)
<b>Exterior Height</b>	IN (CM)	31 (77)	31 (77)	34 (85)	35 (89)	35 (89)	40 (102)
<b>Exterior Width</b>	IN (CM)	23 (58)	23 (58)	25 (65)	28 (71)	28 (71)	29 (74)
<b>Rotor Diameter</b>	IN (CM)	15 (38)	15 (38)	16 (41)	18 (45)	18 (45)	20 (50)
<b>Approximate Weight</b>	LBS (KG)	1,100 (499)	1,307 (593)	1,668 (757)	2,150 (975)	2,614 (1,188)	3,707 (1,681)

## HYDRAULICS

<b>Variable Displacement Axial Piston Motor</b>	CC	28	60	80	110	110	160
<b>Min. Required Continuous Flow</b>	GAL/MIN (L/MIN)	15 (57)	23 (87)	30 (114)	42 (159)	42 (159)	51 (193)
<b>Max. Required Continuous Flow</b>	GAL/MIN (L/MIN)	22 (83)	38 (144)	44 (167)	63 (238)	63 (238)	91 (344)
<b>Max. Operating Pressure</b>	PSI (BAR)	6,000 (410)	6,000 (410)	6,000 (410)	6,000 (410)	6,000 (410)	6,000 (410)
<b>Rotating Speed</b>	RPM	3,800	3,500	3,500	3,000	3,000	3,000

## FEATURES

<b>Tilting System</b>	Optional	Optional	Optional	Optional	Optional	Optional
<b>Bolt-on Wear Liner</b>	N/A	N/A	Included	Included	Included	Included
<b>Grapple System</b>	N/A	Optional	Optional	Optional	Optional	Optional

This information is subject to change without notice.



# EXCAVATOR MINI BITE LIMITER MULCHER

## VL SERIES

Shearex's Mini Bite Limiter Mulcher attachment is the ultimate tool for fast and efficient roadside maintenance, invasive species removal, land clearing, and underbrush maintenance!

With years of experience, Shearex offers one of the most powerful land-clearing attachments on the market, featuring a quick and easy coupling system.



		VL-20SC	VL-30SC
Excavator Size	T	2 to 4	3 to 4
Recommended Min. Carrier Power	HP (KW)	15 (20)	23 (30)
Cutting Width	IN (CM)	21.25 (54)	31 (78)
Cutting Distance From Ground Level	IN (CM)	0.25 (0.64)	0.25 (0.64)
Number of Blades on Rotor		8	12
Optimal Target Mat. Dia.	IN (CM)	<3 (<75)	<4 (<10)
Exterior Length	IN (CM)	32.5 (83)	42 (107)
Exterior Height	IN (CM)	22.75 (58)	22.75 (58)
Exterior Width	IN (CM)	18 (45)	18 (45)
Rotor Diameter	IN (CM)	13 (33)	13 (33)
Approximate Weight	LBS (KG)	430 (195)	550 (249)

## FEATURES

Tilting System	-	-
Bolt-on Wear Liner	-	-
Grappling Hook	-	-
Heel	Optional	Optional
Front free door	Optional	Optional
18cc motor	Optional	Standard

## HYDRAULICS

		VL-20SC	VL-30SC
Fixed Axial Piston Motor	CC	12	18
Min. Required Continuous Flow	GAL/MIN (L/MIN)	30 (8)	49 (13)
Max. Required Continuous Flow	GAL/MIN (L/MIN)	18 (68)	18 (68)
Max. Operating Pressure	PSI (BAR)	400 (5,800)	400 (5,800)
Rotating Speed	RPM	3,500	3,500
Pulley Ratio		1:1	1:1
Pressure Line I.D.	# (IN)	#10 (0,625)	#10 (0,625)
Return Line I.D.	# (IN)	#10 (0,625)	#10 (0,625)
Drain Line I.D.	# (IN)	None	None

## INCLUDED WITH ALL VL MULCHERS COMPLIMENTARY KIT

Every VL mulcher comes with a complimentary kit packed with essentials to get you up and running.

- Eight blades (bolts included)
- One tube of grease
- Shearex cap
- User manual
- Sharpening guide





SHEAREX  
HYDRA-SHEAR



## SHEAREX MULCHER STARTUP SERVICE

At Shearex, we're dedicated to ensuring your mulcher delivers top performance from day one. That's why every new mulcher purchase comes with our comprehensive Startup Services at no additional cost. Our expert technicians will travel to your site—no matter where you are—to fine-tune the mulcher to your carrier for maximum efficiency.

We also provide a quick training session on proper maintenance techniques, helping you extend the lifespan of your equipment.

With Shearex, you get more than just a mulcher—you get unmatched support for optimal results.

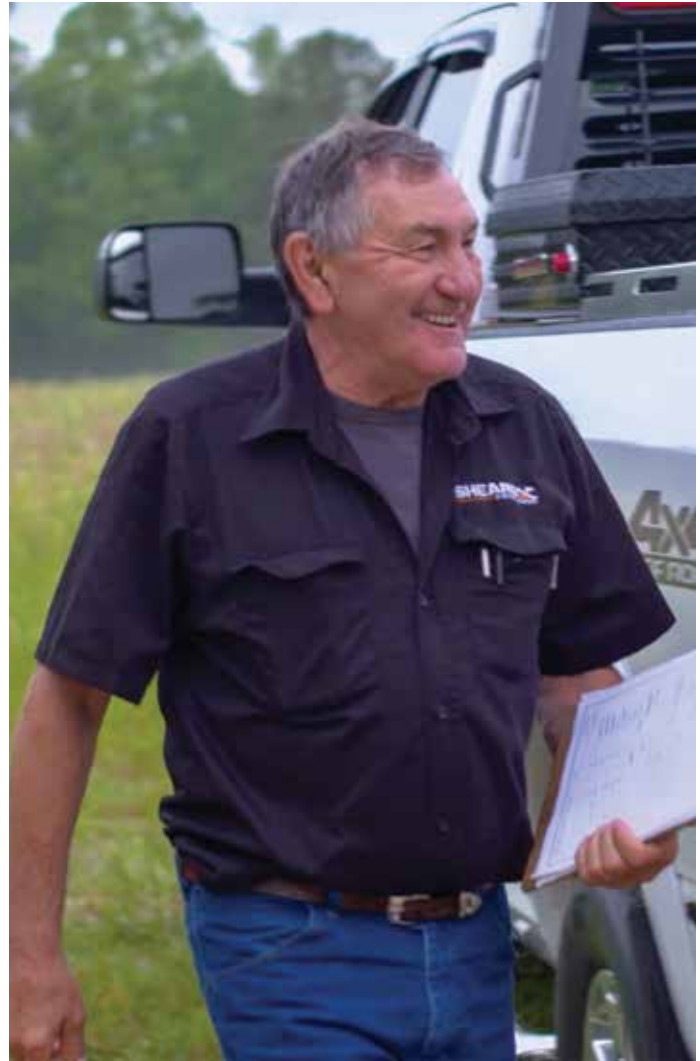

### INCLUDED WITH ALL VM AND HM MULCHERS **CUSTOMER KIT**

Shearex offers a customer kit with every HM and VM Series mulcher purchase, including a set of spare blades, hardware and a battery-powered grinder to sharpen your blades.



# BLADE TYPES

Depending on your operation, choose between our different blade types when ordering your mulcher to provide maximum durability to your equipment.

## BITE LIMITER SHARP TEETH

Our advanced **cutting blades** are available for all your land clearing and forestry applications in regions with fine textured soils where high efficiency is key. Offered in both standard and high abrasion resistant materials, ensuring Shearex has the perfect pairing for your application. Choose between Type 10 or Type 20 blades.

### TYPE 10 BLADES

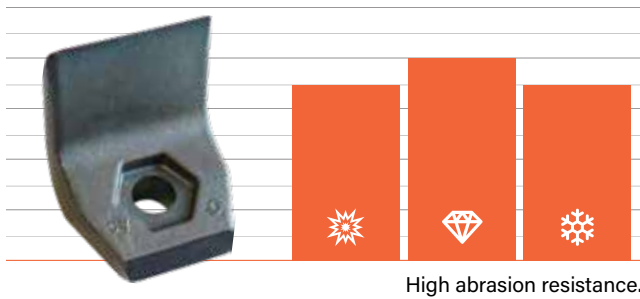

### TYPE 20 BLADES

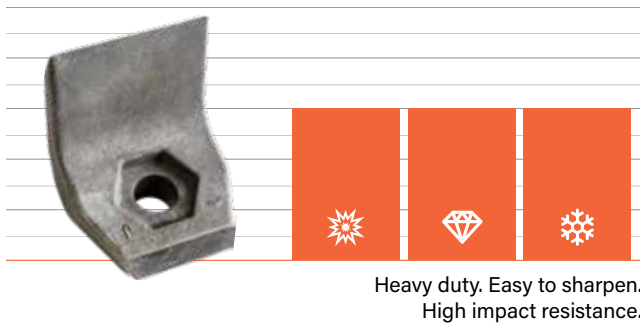

## SOLID DRUM HAMMERS

The HD Series solid drum mulcher is comprised of **central** and **lateral carbide blades**, for optimal performance and durability. Find high resistance hammers on both ends of the rotor to maximise your mulching operations.

### SOLID DRUM CENTRAL BLADES (HD SERIES ONLY)

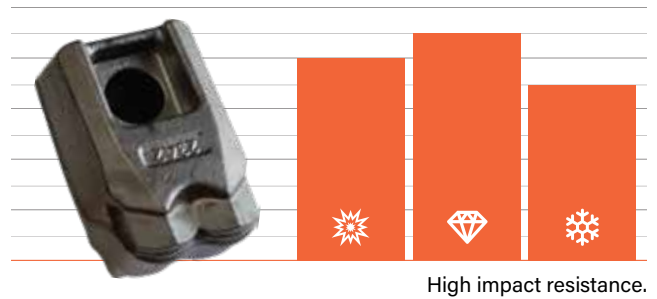

### SOLID DRUM LATERAL BLADES (HD SERIES ONLY)

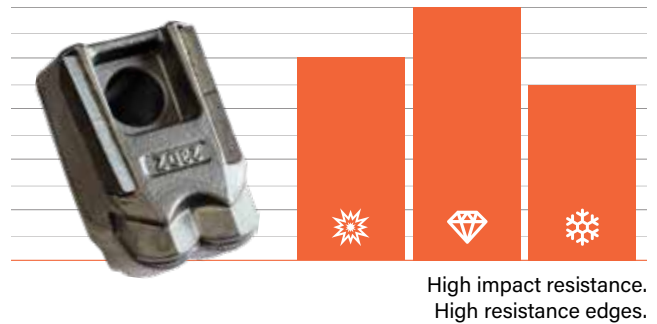

## CARBIDE BLADES

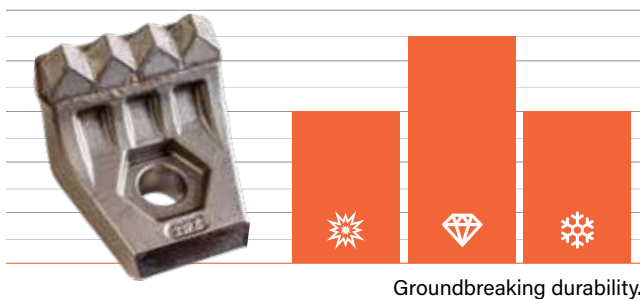

## BITE LIMITER CARBIDE TEETH

Shearex **carbide blades** are available for all of your land clearing operations. Choose these blades for land clearing near roads, where asphalt parts can be found, or in fields where the ground could be more rocky. These hammers provide ground breaking durability to your equipment.

 IMPACT RESISTANCE

 ABRASION RESISTANCE

 COLD RESISTANCE







# FORESTRY ATTACHMENTS



# HARVESTER SHEAR

## FHS SERIES

Finish your land clearing jobs in-depth by uprooting and cutting roots, stumps, and biomass beyond the reach of your other land clearing tools.

**LOW MAINTENANCE**

**EXTREME CUTTING FORCE**

**HIGH QUALITY STEEL**

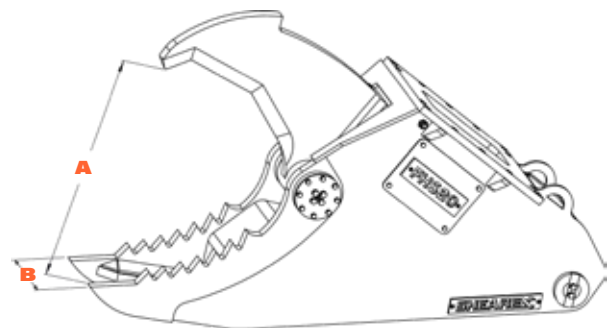

MODEL	CARRIER TONS	WEIGHT LBS (KG)	OPENING IN (MM) <b>A</b>	WIDTH IN (MM) <b>B</b>	DEPTH IN (MM)	PRESSURE PSI (BAR)	FORCE TONS
FHS20	15-25	2,680 (1,218)	39 (990)	15 (400)	28 (711)	5,000 (350)	30
FHS30	25-35	4,640 (2,110)	55 (1,400)	18 (457)	37 (940)	5,000 (350)	45

This information is subject to change without notice.



# STUMP SHEAR

## SS SERIES

The Shearex stump shear is perfect for land clearing, designed to uproot, break down, and split large stumps into manageable pieces for shredding. Tackle tough stumps efficiently and finish your job in-depth with ease.

### EASY MAINTENANCE

### POWERFUL GRIP

### AVAILABLE IN HYDRAULIC OR MECHANICAL CONFIGURATIONS

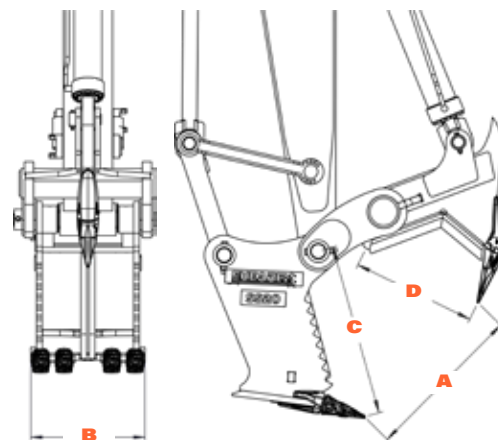

MODEL	CARRIER TONS	WEIGHT LBS (KG)	OPENING IN (MM) <b>A</b>	WIDTH IN (MM) <b>B</b>	TIP RADIUS IN (MM) <b>C</b>	CUT LENGTH IN (MM) <b>D</b>	MECHANICAL CONFIG.
SS16	12-16	2,315 (1,050)	52 (1,321)	22 (559)	32 (813)	21 (533)	Available
SS20	15-24	2,811 (1,275)	58 (1,473)	25 (635)	34 (864)	24 (610)	Available
SS27	18-25	3,858 (1,750)	64 (1,626)	30 (762)	42 (1,067)	30 (762)	Available
SS30	25-38	5,512 (2,500)	68 (1,727)	30 (762)	43 (1,092)	31 (787)	Available
SS40	30-50	7,716 (3,500)	72 (1,828)	32 (813)	48 (1,219)	34 (864)	Available

This information is subject to change without notice.



# TREE SHEAR

## FTS SERIES

With its multiple tree capacity, its powerful replaceable cutting blade and its 360-degree rotation, the Shearex tree shear is a natural choice for those who seek to cut down a whole tree in a matter of seconds.

### PROTECTED CYLINDERS

### POWERFUL GRIP & CUT

### OPTIMAL ACCUMULATOR

### 360° OF POWERFUL ROTATION

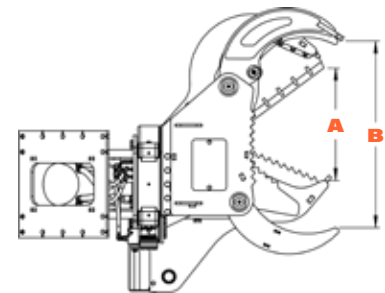
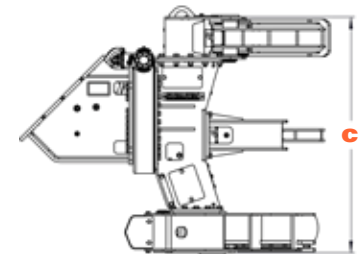

MODEL	CARRIER TONS	WEIGHT* LBS (KG)	OPENING IN (MM) <b>A</b>	GRAPPLING IN (MM) <b>B</b>	HEIGHT IN (MM) <b>C</b>	FORCE TONS	PRESSURE PSI (BAR)	HYD. FLOW GAL/MIN (L/MIN)
FTS12	8-14	1,300 (590)	18 (457)	33.5 (850)	47 (1,194)	16	3,626 (250)	15-21 (60-80)
FTS16	12-18	2,420 (1,100)	25 (635)	43 (1,092)	56 (1,422)	37	4,351 (300)	21-26 (80-100)
FTS20	16-24	3,960 (1,800)	30 (749)	43 (1,092)	68 (1,727)	45	4,351 (300)	34-40 (130-150)
FTS25	21-35	4,620 (2,100)	34 (850)	59 (1,498)	73 (1,854)	51	4,351 (300)	40-48 (150-180)

\*Weight does not include rotation and accumulator. This information is subject to change without notice.

# MINI TREE SHEAR

## FTS SERIES

The Shearex mini tree shear is a natural choice for those who seek to cut down a whole tree in a matter of seconds. Its powerful replaceable cutting blade makes it the best product for rapidly cutting and moving whole trees for other specialised units to transport and process. The Shearex mini tree shear is an effective and easy way to jumpstart your forestry production output.



### SHEAR TREES UP TO 7" DIAMETER

### POWERFUL GRIP & CUT

### EASY MAINTENANCE

### ACCUMULATOR INCLUDED

	CARRIER TONS	WEIGHT* LBS (KG)	OPENING IN (MM)	GRAPPLING IN (MM)	HEIGHT IN (MM)	FORCE TONS	PRESSURE PSI (BAR)	HYD. FLOW GAL/MIN (L/MIN)
FTS07	5-9	950 (431)	35 (889)	35 (889)	24 (609)	11	3,191 (220)	13-15 (50-60)

This information is subject to change without notice.

# WOOD CONE SPLITTER

## SC SERIES

Split your logs with power and ease. The Shearex wood cone splitter will handle a large amount of workload very fast! Its robust design with replacable tips will increase your productivity by splitting your bigger logs, stumps and roots with this splitter before sending it into your shredding equipment.



### IMPRESSIVE SPLITTING POWER

### REPLACABLE TIP

### EASY MAINTENANCE

### IDEAL FOR FORESTRY

SPECIFICATIONS		SC15	SC34
Carrier Size	TONS	3 to 9	10 to 30
Weight	LBS (KG)	700 (318)	1,650 (750)
Cone Diameter	IN (MM)	13.5 (343)	15.5 (394)
Height	IN (MM)	22 (559)	25 (635)
Pressure	PSI (BAR)	5,000 (350)	5,000 (350)
Hyd. Flow	GAL/MIN (L/MIN)	10-25 (38-100)	20-50 (75-190)
Torque	LBS-FT (NW)	10,500 (15,500)	10,500 (15,500)
Stump Grinder		Optional	Optional

This information is subject to change without notice.

# STUMP GRINDER

## SG SERIES

The Shearex stump grinder has been designed for maximum efficiency, unrivalled speed and minimal impact on the environment. With Shearex, no time is wasted on clean-up: our stump grinder quickly pulverizes stumps and buried residues, leaving your work sites clean and ready for new planting or maintenance vehicle traffic.

Blade system interchangeable **in less than 5 minutes.**

Adapt your equipment to different applications and **soft or hard wood.**

Equipped with a high-performance, **low-maintenance motor** guaranteeing constant, reliable power every time.

Designed to **minimize downtime and optimize your time** in the field.

**Our advanced technology and Hardox® 500 blades** will ensure you meet the demands of the toughest jobs, while respecting the environment.

**Rapid availability of wear and replacement parts:** You don't have to worry about long waiting times - everything you need is at hand to keep your equipment up and running.



### AVAILABLE BLADE TYPES



Standard Straight Blades



Notched Blades

### SPECIFICATIONS

		SG15	SG24	SG34
Carrier Size	TONS	3-6	6-14	12-30
Cut Diameter	IN (MM)	15 (380)	24 (600)	34 (860)
Maximum Pressure	PSI (BAR)	5,500 (379)	5,500 (379)	5,500 (379)
Maximum Hydraulic Flow	GAL/MIN (L/M)	10-25 (38-100)	14-35 (62-145)	22-50 (100-225)
Minimum Speed	RPM	50	35	35
Maximum Speed	RPM	110	60	50
Maximum Torque*	FT-LBS (Nm)	10,500 (14,250)	13,000 (17,000)	32,000 (45,000)
Cone Splitter (Optional)	IN	14	16	16

This information is subject to change without notice. \* Maximum torque may vary depending on maximal pressure.



# BRUSH GRAPPLE

## BG SERIES

Introducing the Brush Grapple by Shearex, a powerful and versatile tool designed to excel in forestry, recycling, scrap yards, construction, agriculture, and storm clean up application. Featuring an open-end design, it allows you to handle a wide range of materials, from logs and brush to roots and bulky debris. With twin hydraulic cylinder grapple arms protected by guards and operating under 3000 PSI of pressure, this attachment provides exceptional heavy-duty capacity for any job.

**PROTECTED CYLINDERS**

**3000 PSI CYLINDER DOUBLE GRAPPLE**

**HYDRAULIC HOSE GUARD**

**UNIVERSAL SKID STEER ATTACHMENT**

### SPECIFICATIONS

		BG-60	BG-72	BG-83HD
Overall Width	IN	60	72	83
Grapple Open	IN	38	38	37
Grapple Closed	IN	16.75	16.75	16
Overall Depth	IN	39	39	36
Weight	LBS	750	825	1,150
Number of Tines		9	11	16
Plate	IN	0.375	0.375	0.5
Tine Spacing	IN	7	6.75	5



This information is subject to change without notice.

# SHEAREX

**1-579-213-0350 - INFO@SHEAREX.CA**

---

**FOLLOW US**     



**SHEAREX.COM**

SH-CA-ALL\_PRODUCT-E-25-02